

 Gemeente Terschelling Beheersverordening Natuurgebieden blad 1 van 8 illustratie		 BügelHajema Flex voor ideeën
datum: 23-09-2014 schaal: 1 : 5000 papierformaat: A0 status: vastgesteld projectnr.: 560.05.12.00.00.06 gezien: BV	BügelHajema Adviseurs B.V. Bureau voor Ruimtelijke Ordening en Milieu ONSP Balnear Bakswal 16, 8314 SE Lauweidant 059 215 25 15 E: bestuur@buegelhajema.nl W: www.buegelhajema.nl	

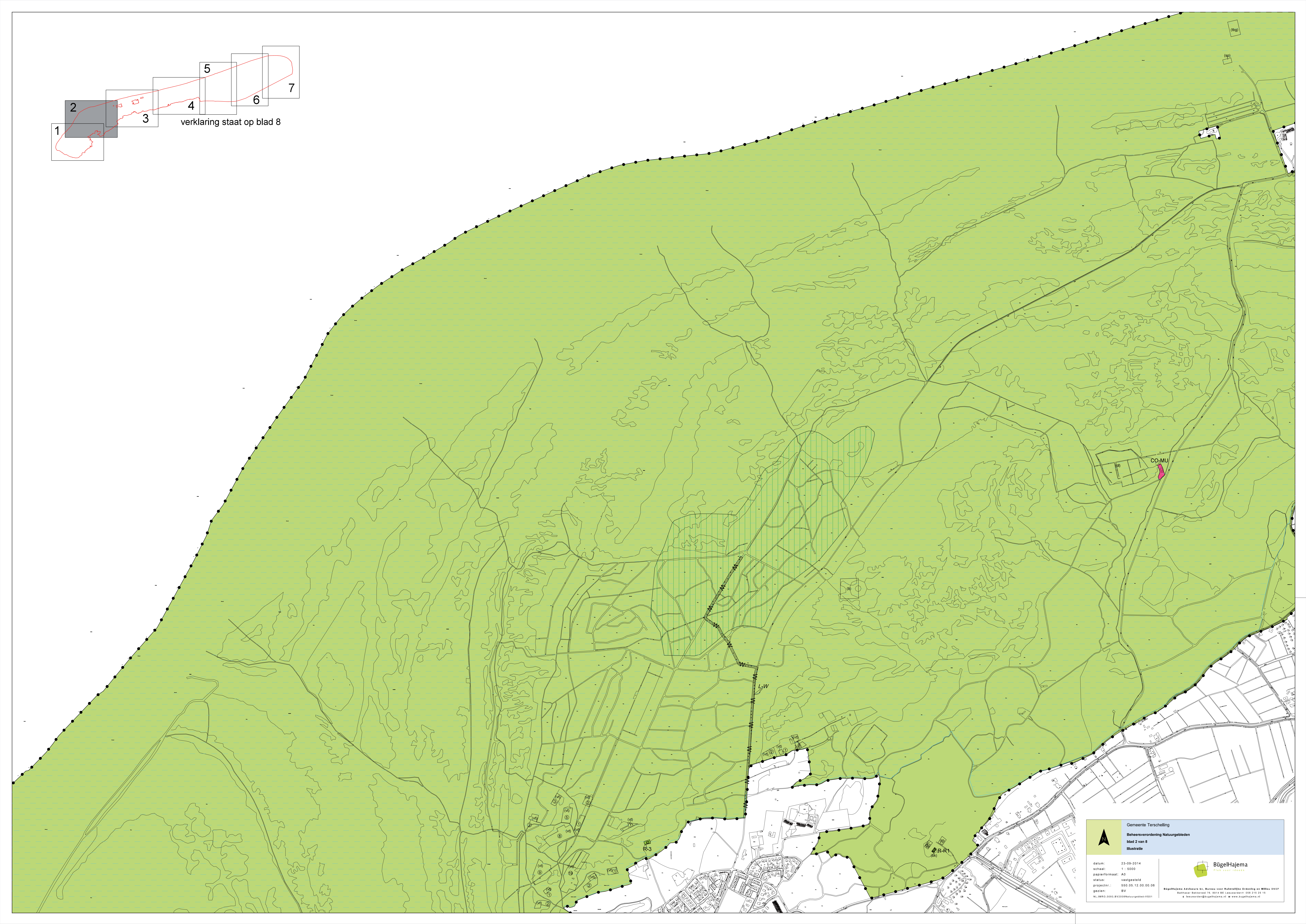

 Gemeente Terschelling Beheersverordening Natuurgebieden blad 2 van 8 illustratie		 BügelHajema <small>Plan voor Leven</small>
datum: 23-09-2014 schaal: 1 : 5000 papierformaat: A0 status: vastgesteld projectnr.: 560.06.12.00.00.06 gezien: BV	<small>BügelHajema Adviseurs bv, Bureau voor Ruimtelijke Ordening en Milieu ONSP Balnear Bakkerwal 16, 8114 DE Ljouwert 059 215 25 15 E: ruimtelijk@buegelhajema.nl W: www.buegelhajema.nl</small>	

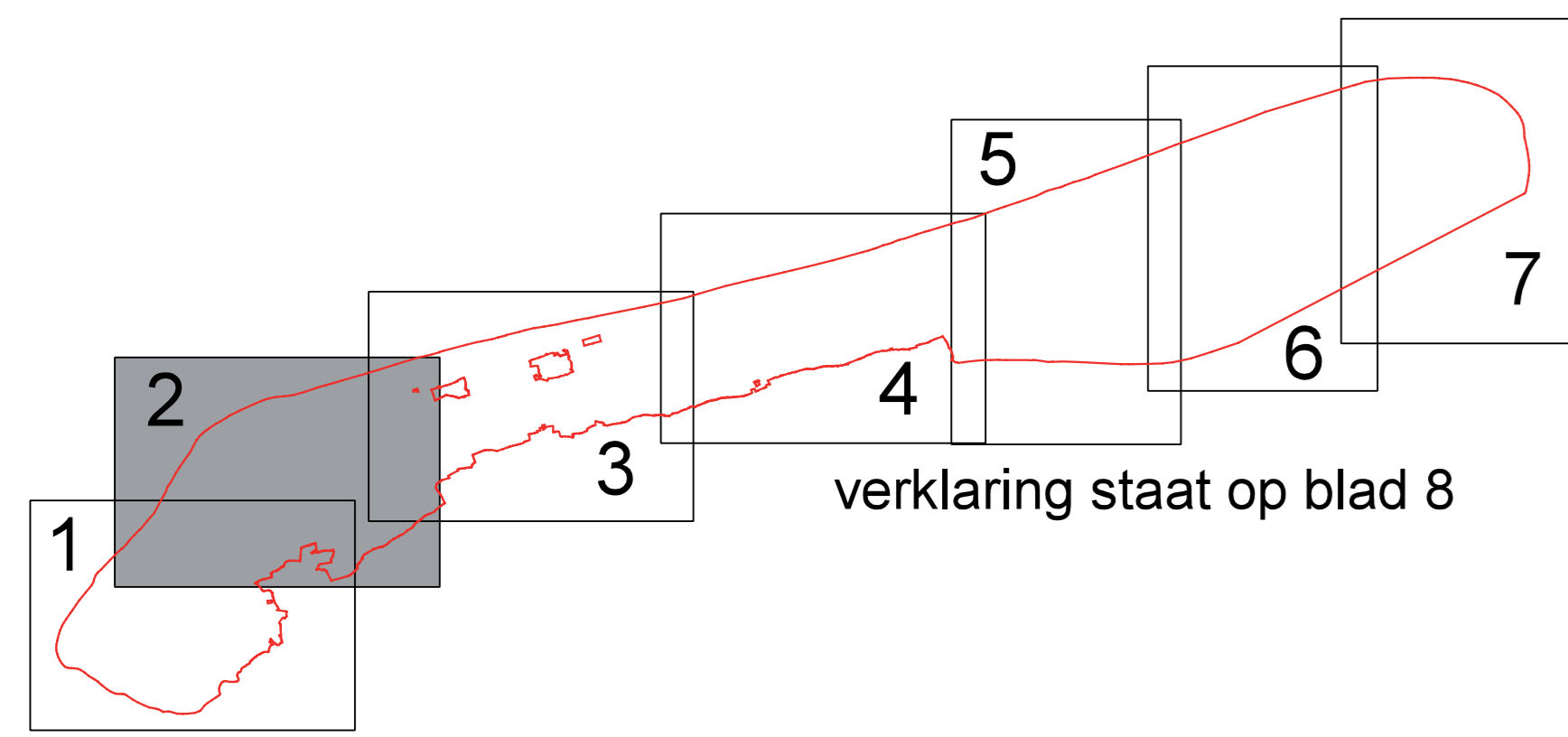

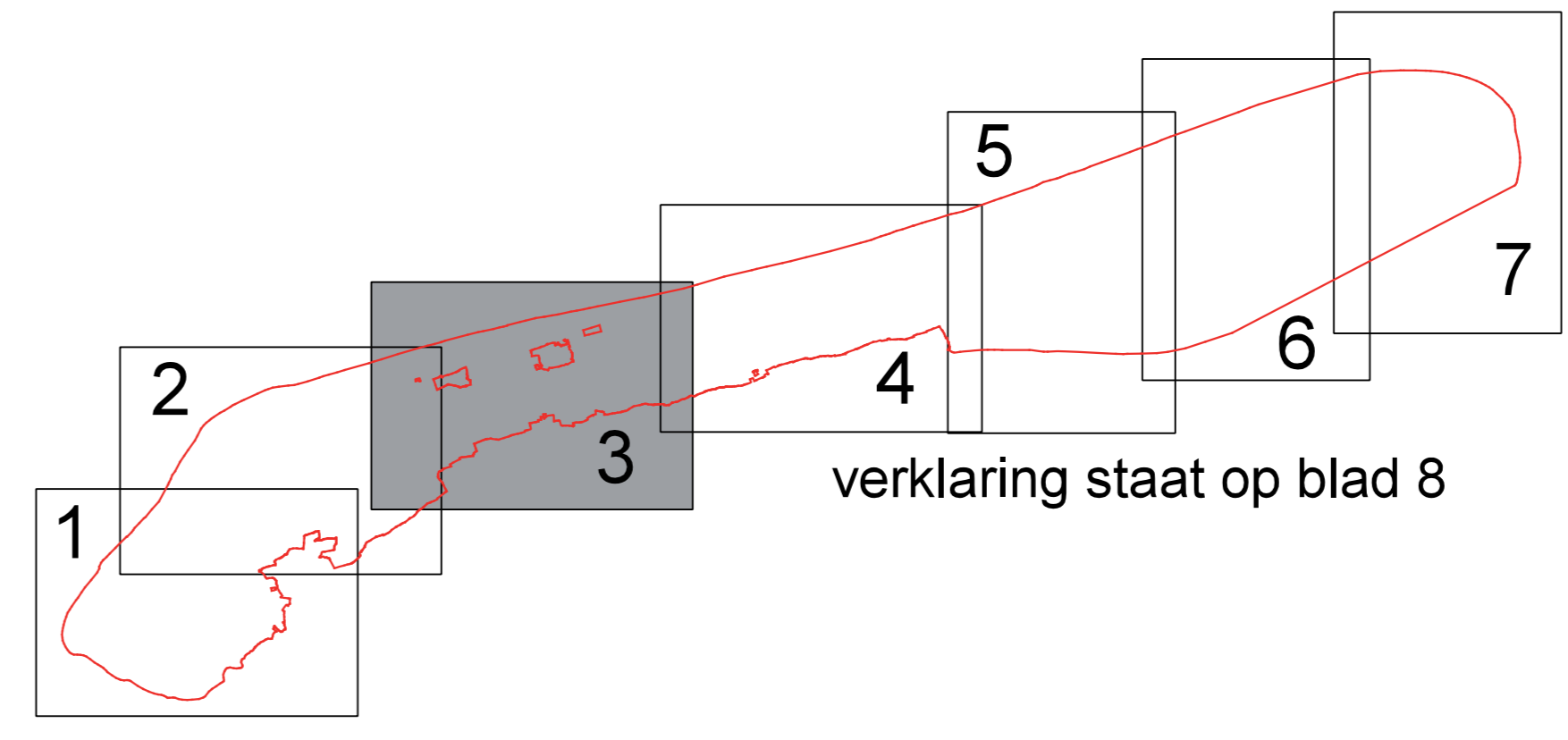
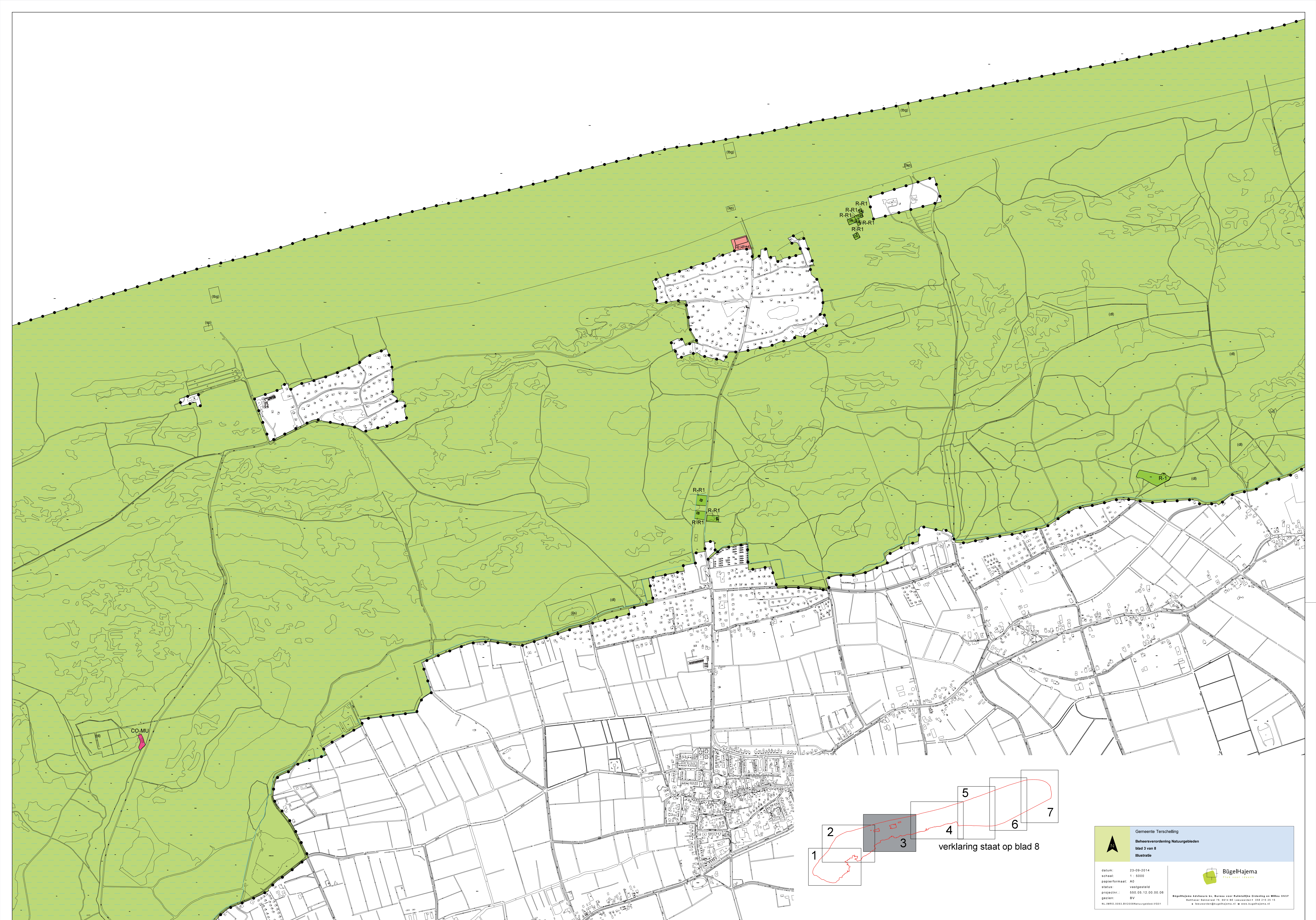

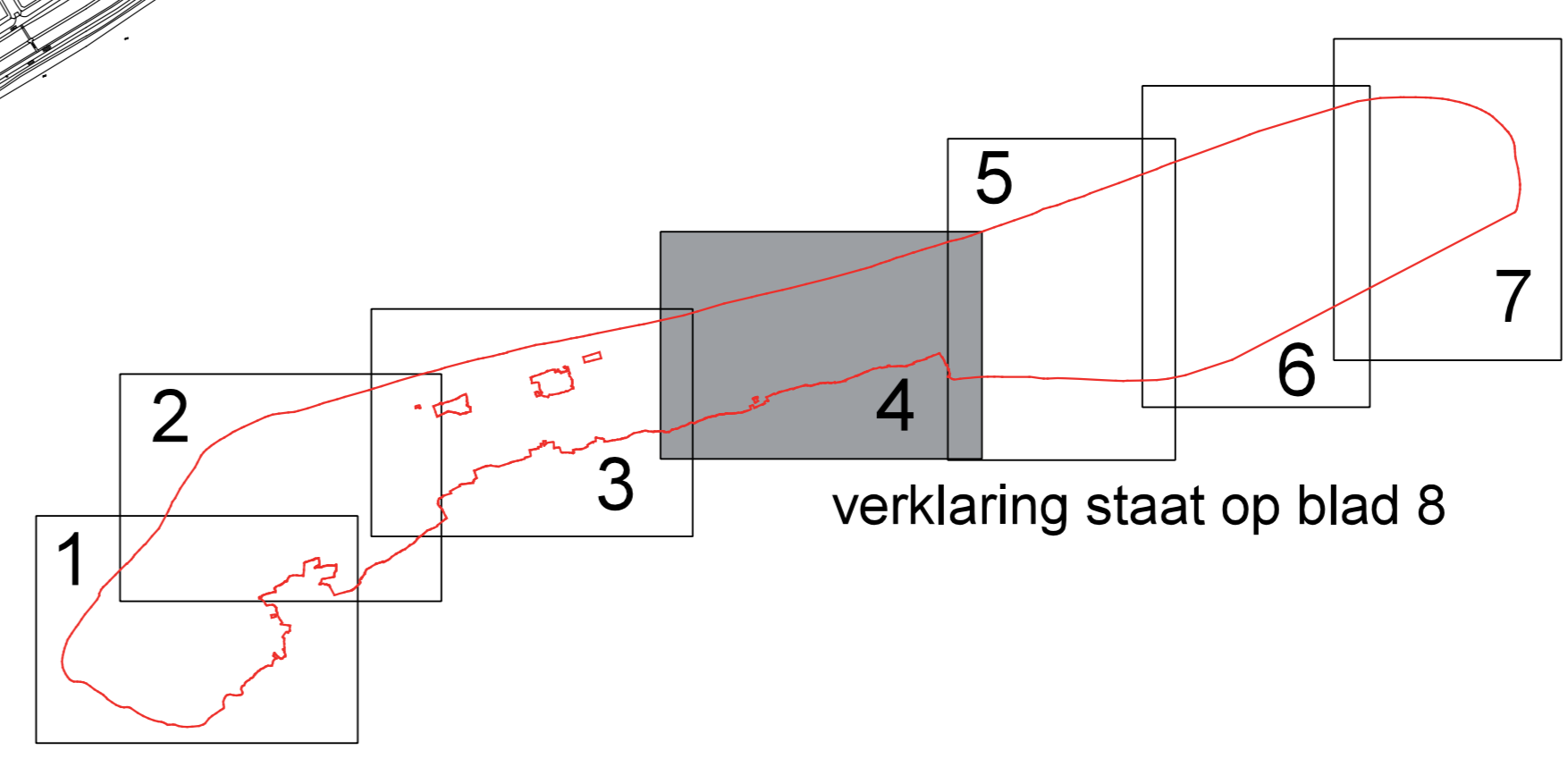
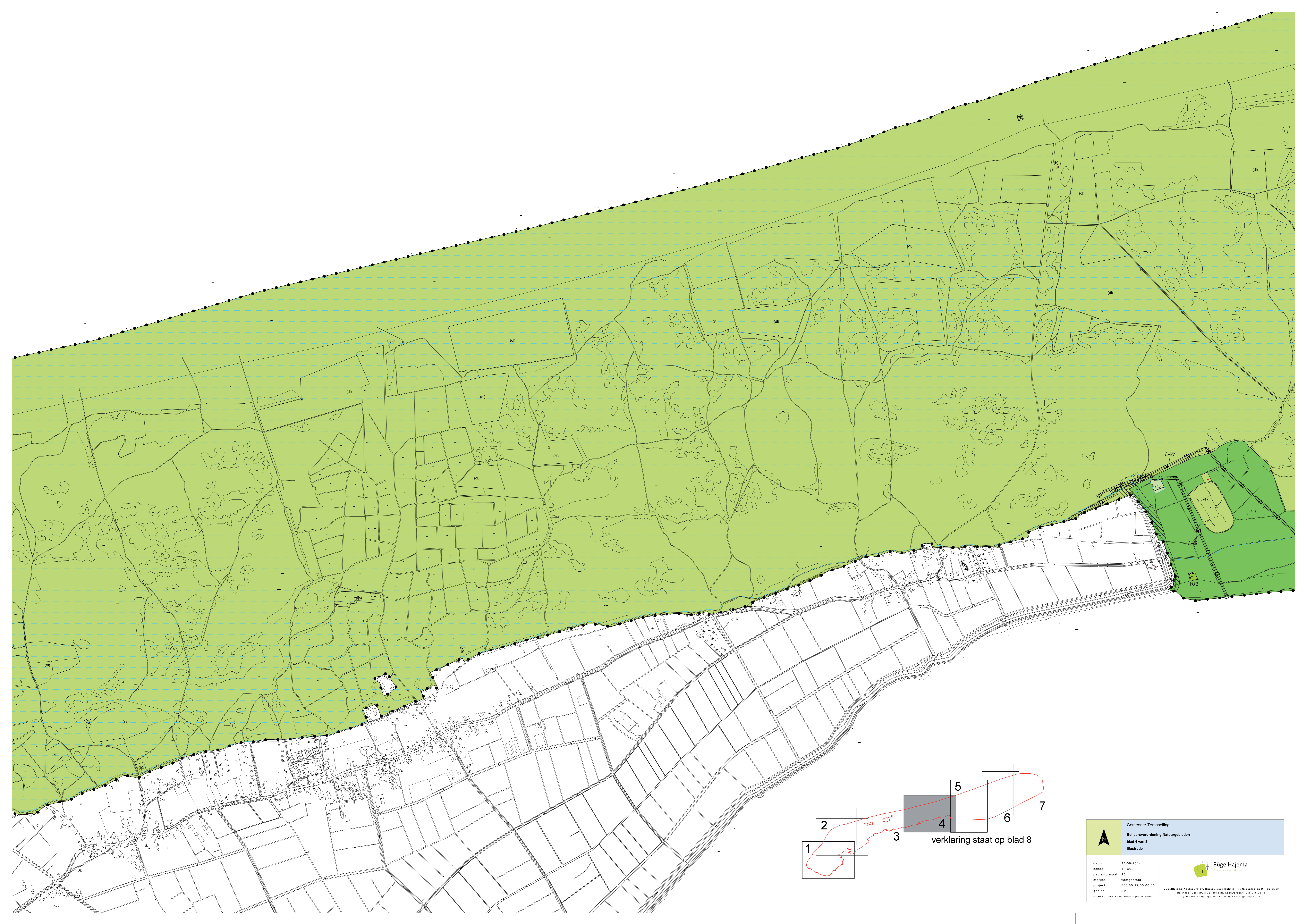
<p>Gemeente Terschelling Beheersverordening Natuurgebieden blad 3 van 8 illustratie</p>		<p>BügelHajema Plan voor Leven</p>
<p>datum: 23-09-2014 schaal: 1 : 5000 papierformaat: A0 status: vastgesteld projectnr.: 560.06.12.00.00.06 gezien: BV</p>	<p><small>BügelHajema Adviseurs bv, Bureau voor Ruimtelijke Ordening en Milieu ONSP Balnear Bakkerwal 16, 9514 BE, Lelouwerik • 059 215 25 15 E: houwelen@buegelhajema.nl W: www.buegelhajema.nl</small></p>	



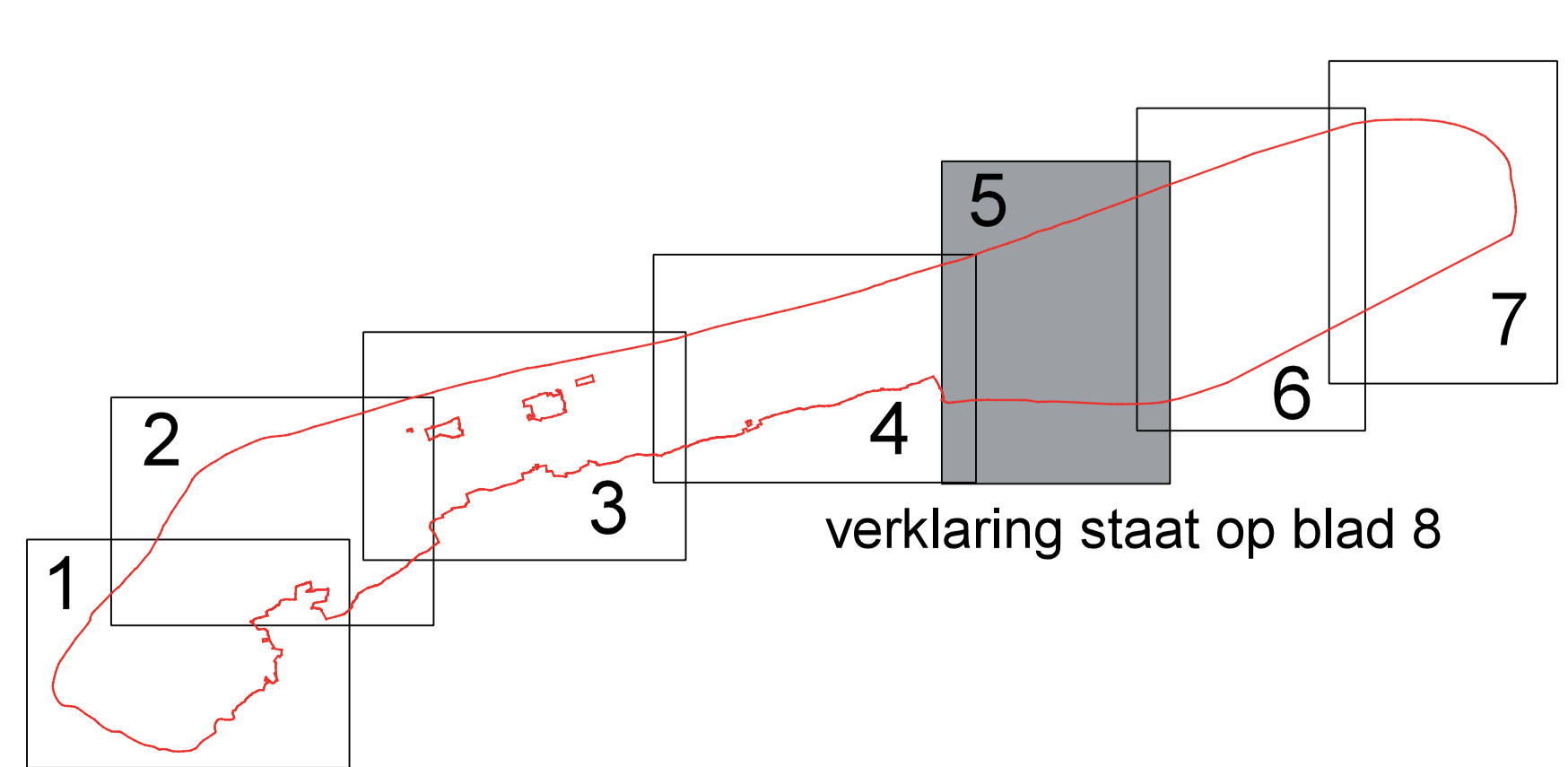
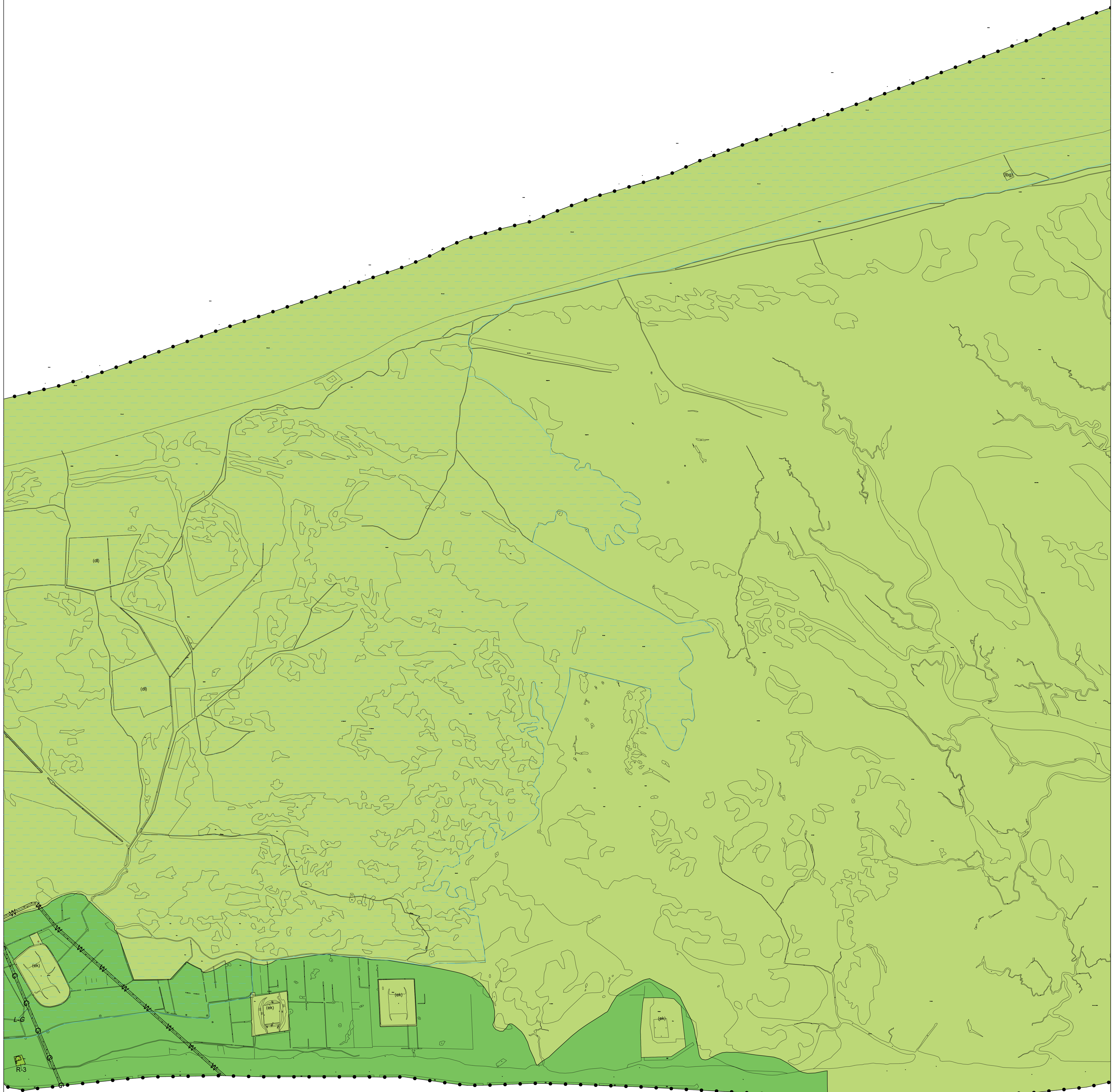

verklaring staat op blad 8

	Gemeente Terschelling Beheersverordening Natuurgebieden blad 4 van 8 illustratie	
	datum: 23-09-2014 schaal: 1 : 5000 papierformaat: A0 status: vastgesteld projectnr.: 560.05.12.00.00.06 gezien: BV <small>NL.IMRD.0003.BV.0008.Natuurgebieden.V001</small>	 BügelHajema <small>Plan voor Leven</small>



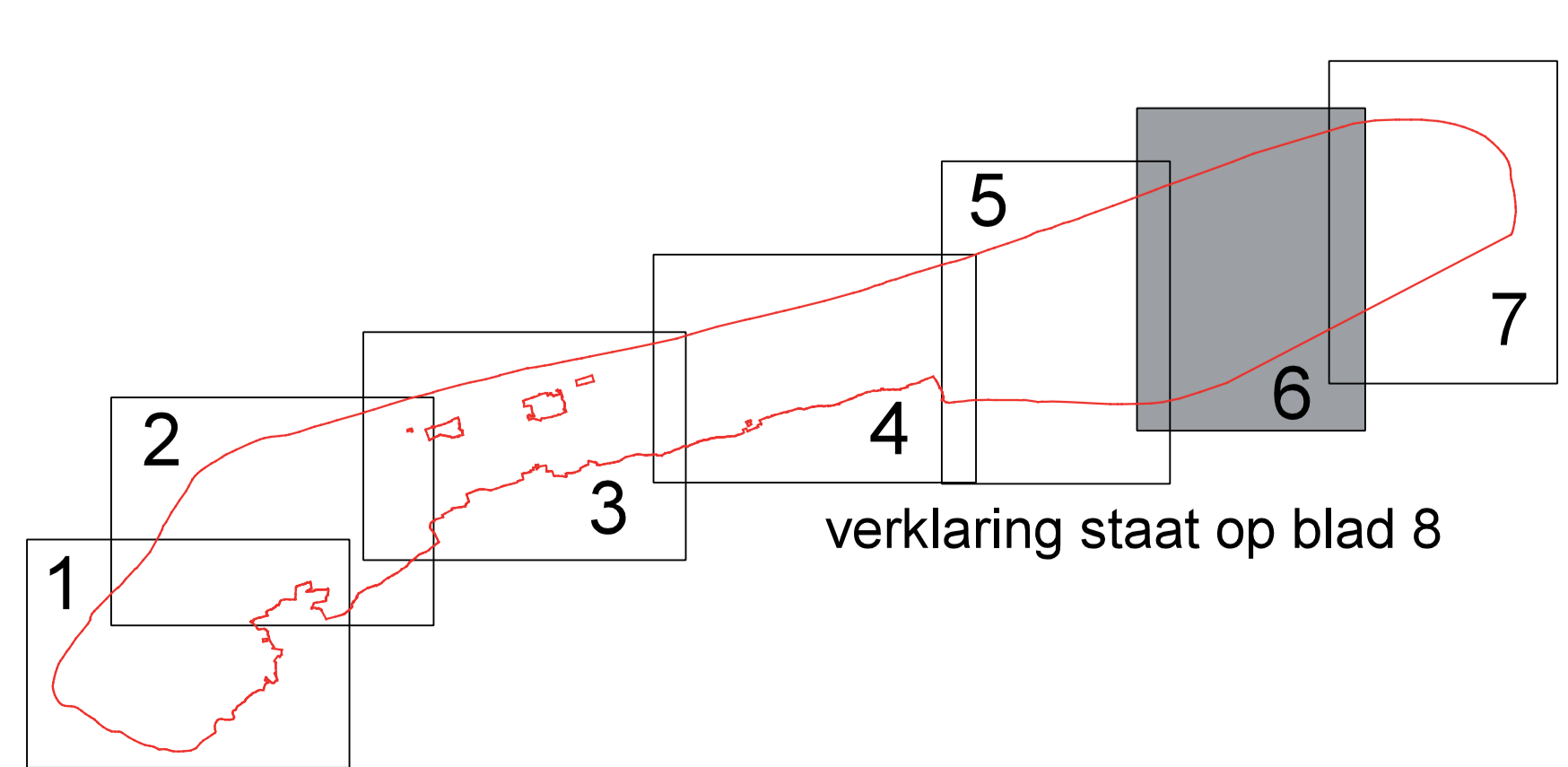
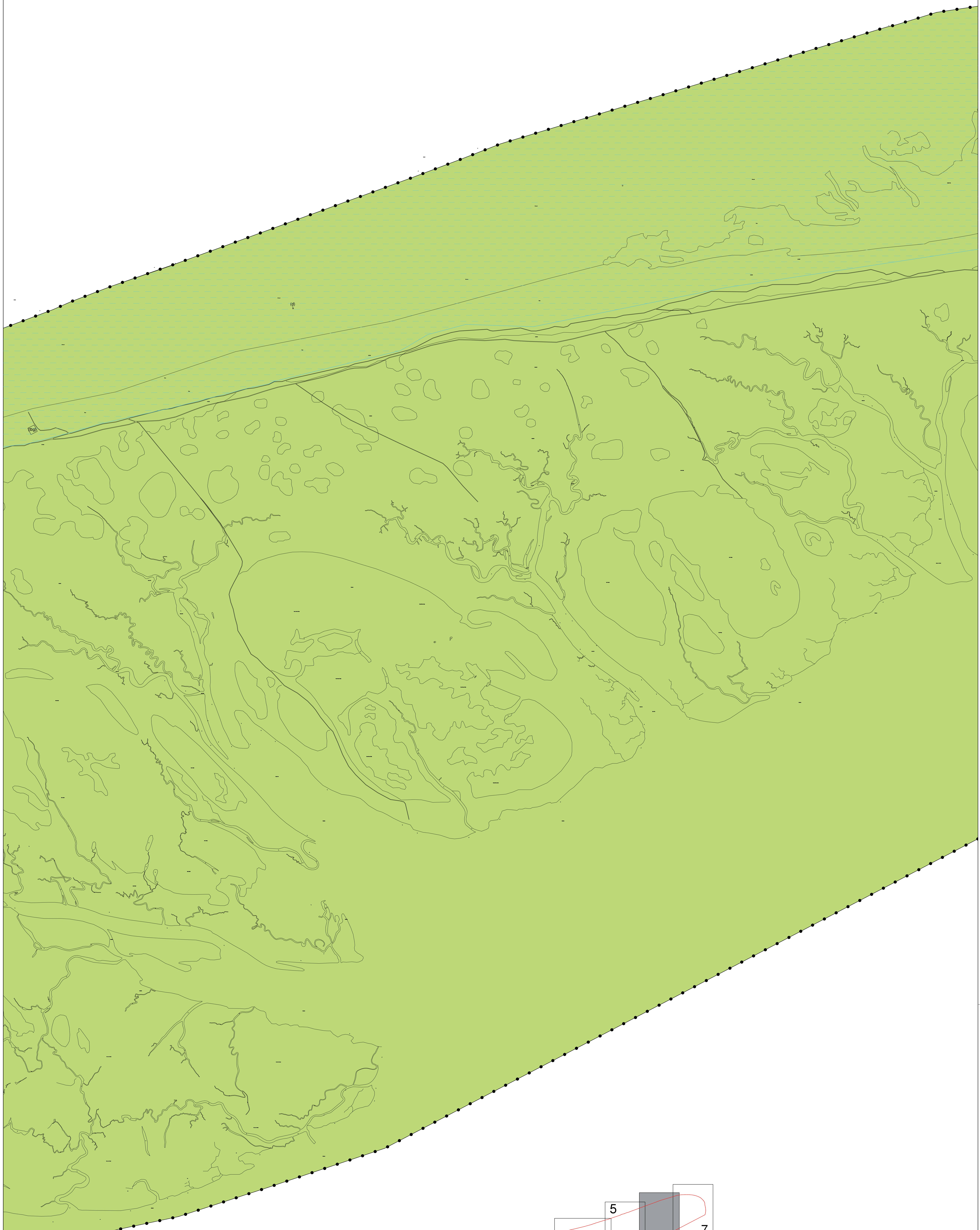

 Gemeente Terschelling Beheersverordening Natuurgebieden blad 5 van 8 illustratie		 BügelHajema <small>Plus voor ideeën</small> BügelHajema Adviseurs bv, Bureau voor Ruimtelijke Ordening en Milieu BNSP Balnear Bakkerwei 75, 6014 DE Leuwarden 050 219 25 15 E leuw@buegelhajema.nl W www.buegelhajema.nl
datum: 23-09-2014 schaal: 1 : 5000 papierformaat: A0 status: vastgesteld projectnr.: 550.06.12.00.00.06 gezien: BV <small>NL.IMRO.0093.BV2008Natuurgebieden-V001</small>		



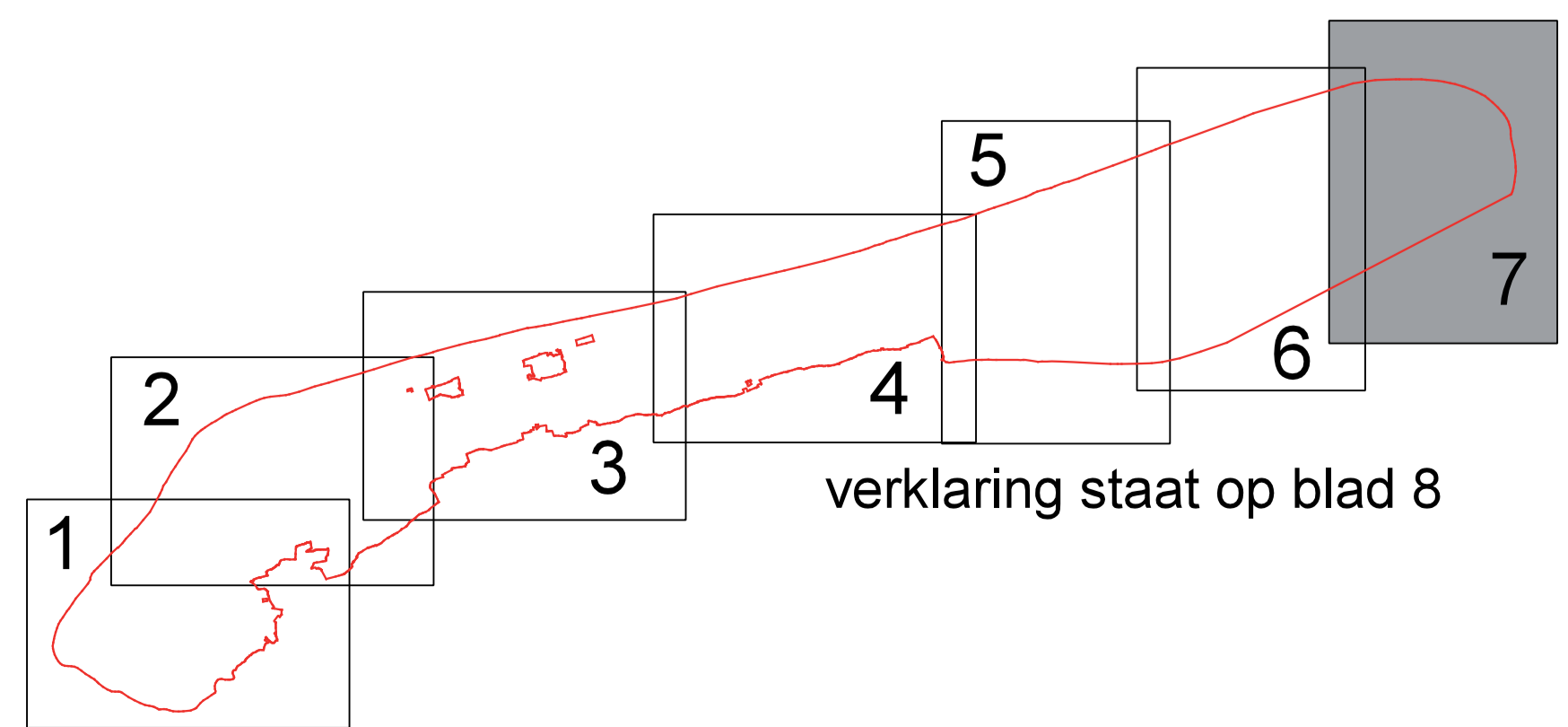





		Gemeente Terschelling Beheersverordening Natuurgebieden blad 6 van 8 Illustratie	
datum: 23-09-2014 schaal: 1 : 5000 papierformaat: A0 status: vastgesteld projectnr.: 550.06.12.00.00.06 gezien: BV		BügelHajema Adviseurs Nv, Bureau voor Ruimtelijke Ordening en Milieu BNSP Balhuysen Bakkerweg 25, 5914 SE Leuwarden 050 219 25 15 E leuwarden@buegelhajema.nl W www.buegelhajema.nl	



Gebiedsbestemmingen

-  Agrarisch - Natuur
-  Agrarisch - Paardenhouderij
-  Natuur

Overige bestemmingen

-  Cultuur en ontspanning - Museum
-  Horeca
-  Recreatie-1 (kampeerterrinen)
-  Recreatie-3 (groepsaccommodaties)
-  Recreatie-Recreatiewoningen-1 (duinen)
-  Wonen

Dubbelbestemmingen

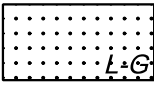
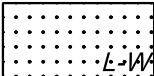
-  Leiding - Gas
-  Leiding - Water

Aanduidingen

-  milieuzone - grondwaterbeschermingsgebied
-  vrijwaringszone - dijk
-  vrijwaringszone - duin
-  beheergebouw
-  bunkers
-  drenkelingshuisje
-  duinland
-  eendenkooi
-  horeca van categorie 4
-  ijsbaan

Aanduidingen (vervolg)

-  strandpaviljoen
-  tijdelijk beheergebouw
-  tijdelijk strandpaviljoen
-  volkstuin
-  bouwvlak
-  hartlijn leiding - gas
-  hartlijn leiding - water

Verklaring

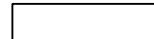
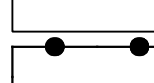
-  Ondergrond ontleend aan de GBKN, meest recente ondergrond
-  bestemmingsgrens
-  grens van het plan



Gemeente Terschelling

Beheersverordening Natuurgebieden

blad 8 van 8

Illustratie

datum: 23-09-2014
schaal: 1 : 5000
papierformaat: A3
status: vastgesteld
projectnr.: 550.05.12.00.00.06
gezien: BV
NL.IMRO.0093.BV2008Natuurgebied-VG01

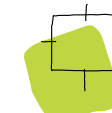

BügelHajema
Plek voor ideeën

BügelHajema Adviseurs bv, Bureau voor Ruimtelijke Ordening en Milieu BNSP
Balthasar Bekkerwei 76, 8914 BE Leeuwarden T 058 215 25 15
E leeuarden@bugelhajema.nl W www.bugelhajema.nl