

RWZI - Tolleane
Areal : 1,15 ha
Schaal 1:500

2880 Panelen
Canadian Solar Inc.
CS3K-300P = 864 kWp

Paneeltafel 180° Zuid; hellingshoek 20°
afstand tussen de rijen 3,75m

Doorsnede Paneeltafel:
schaal 1:50

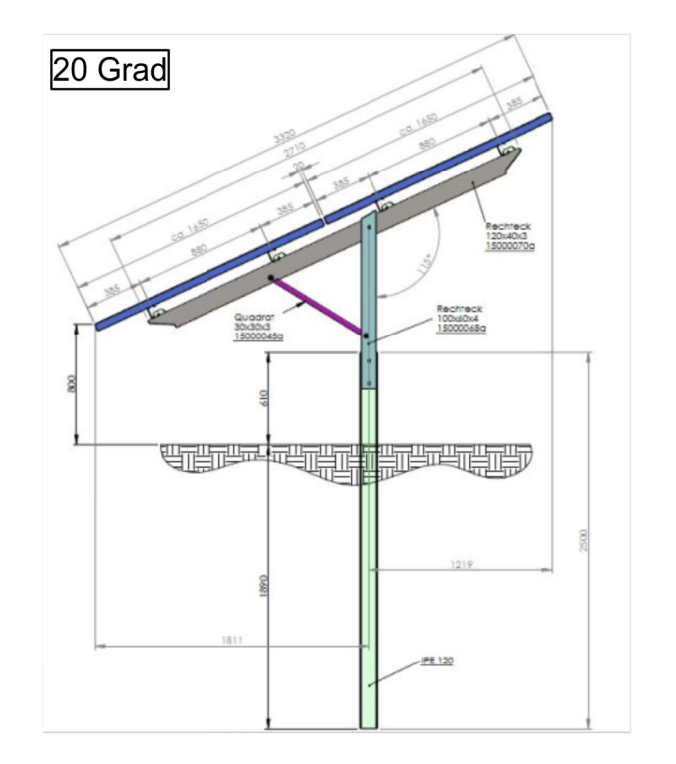

Randtafel:
niet op schaal:

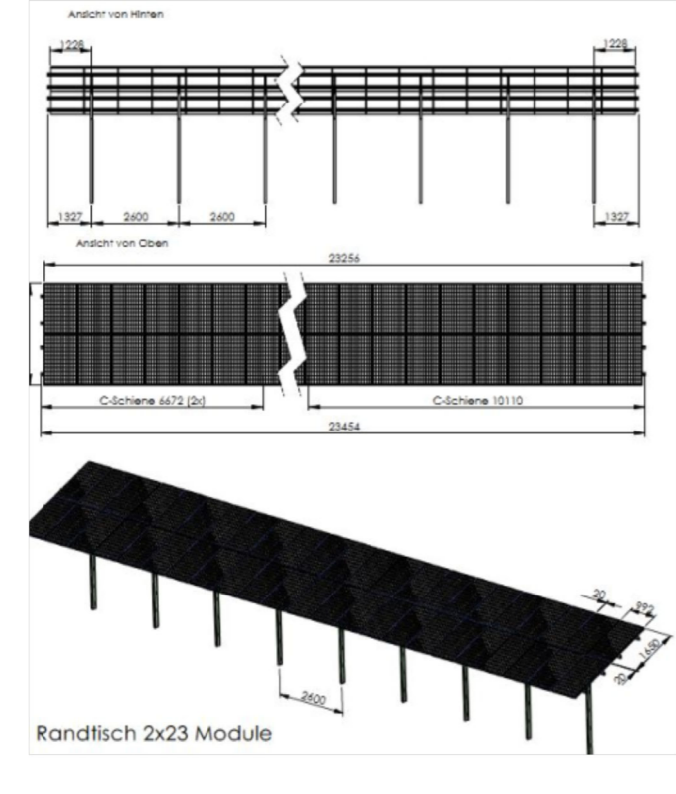

Binnentafel:
niet op schaal:

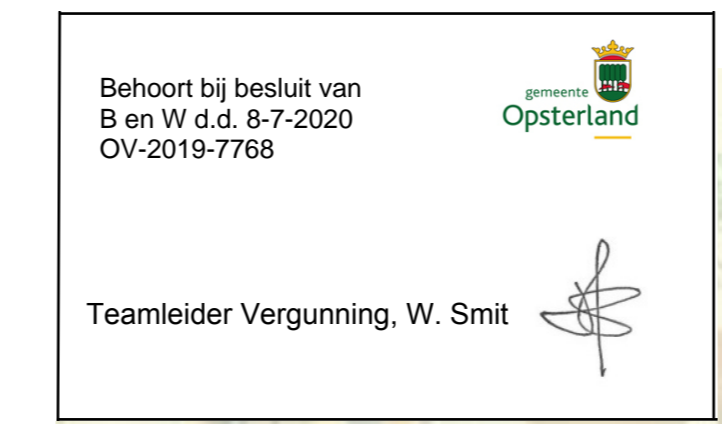
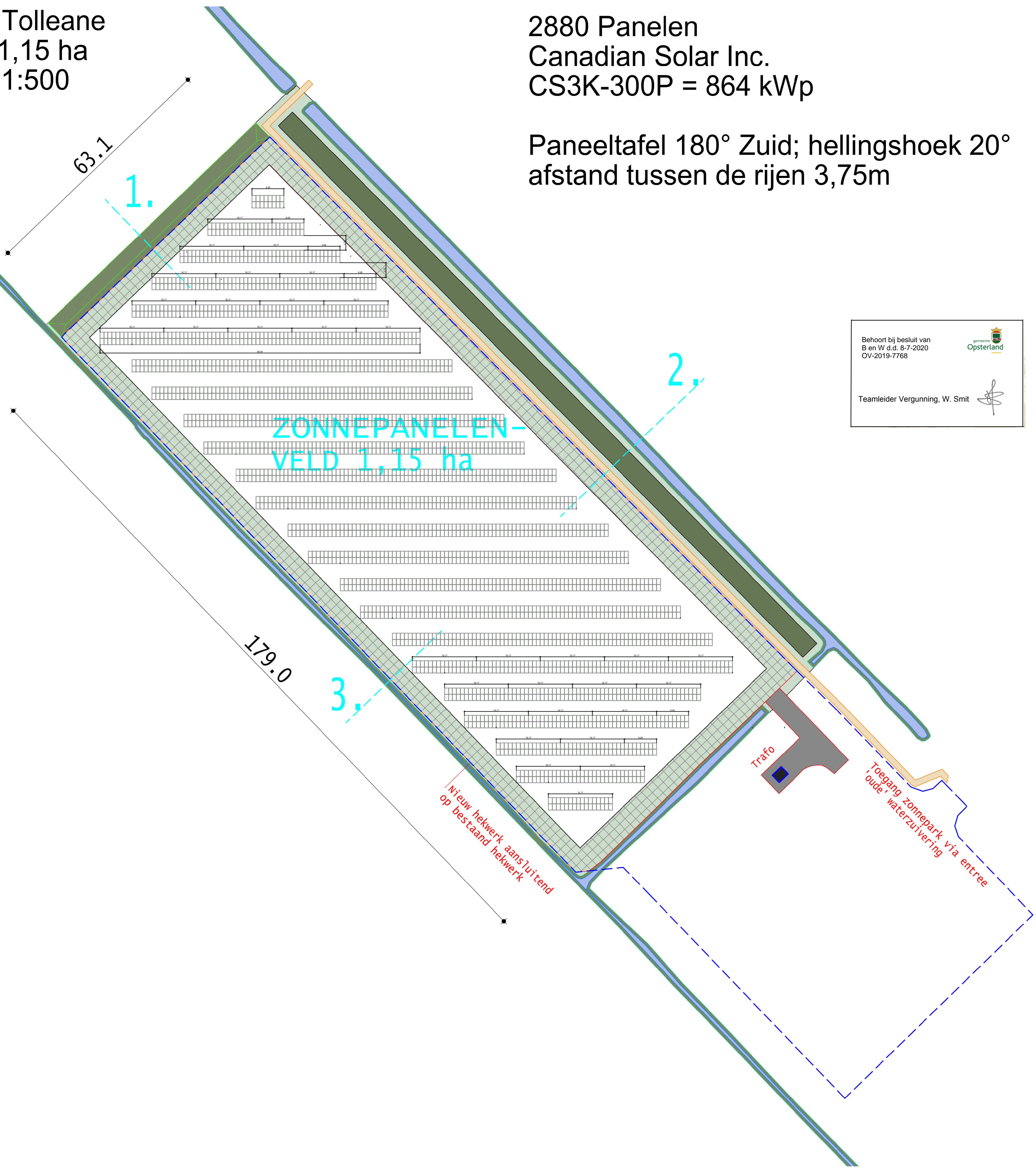
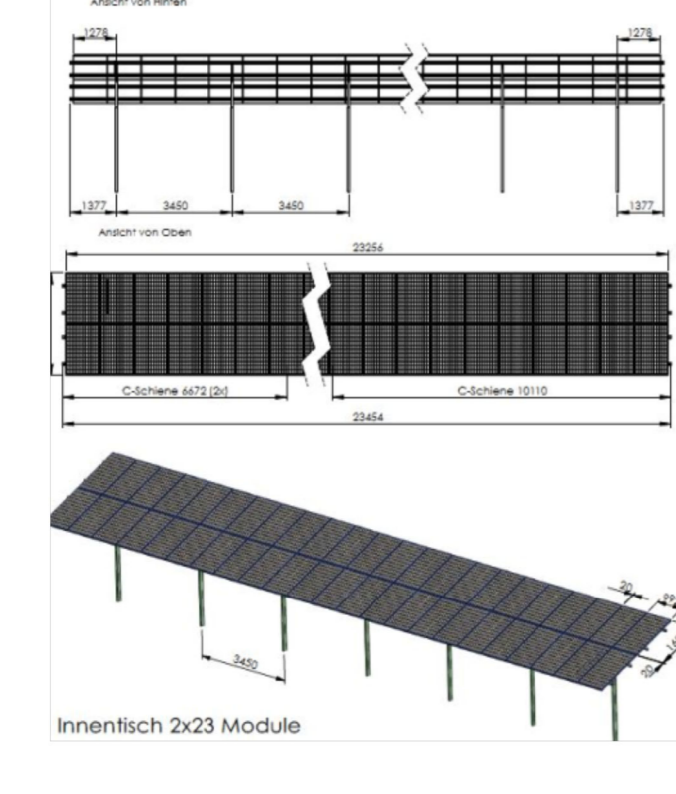

Landschappelijke Inpassing:
schaal 1:100

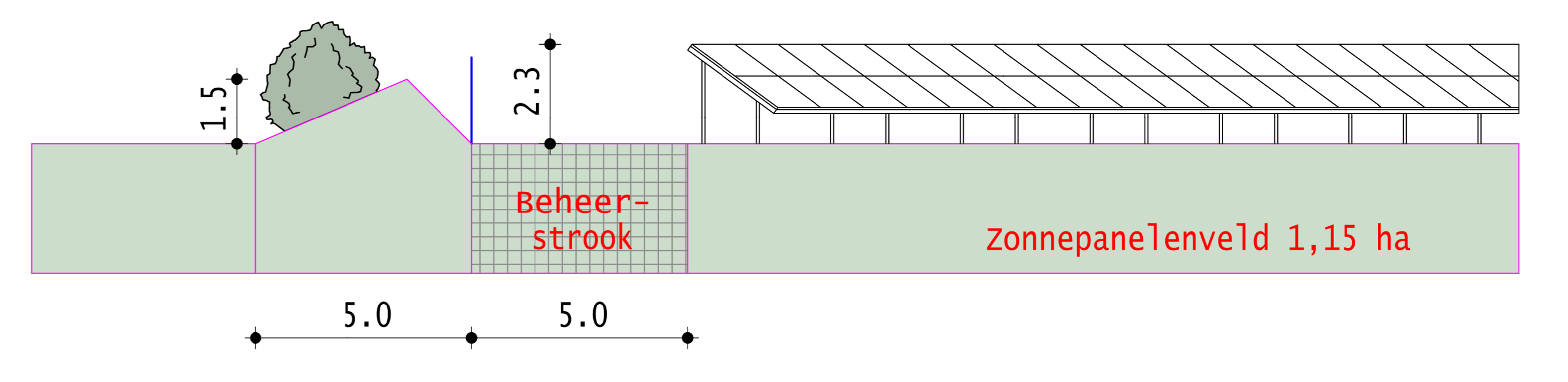

PROFIEL 1. NOORDWESTSTRAND

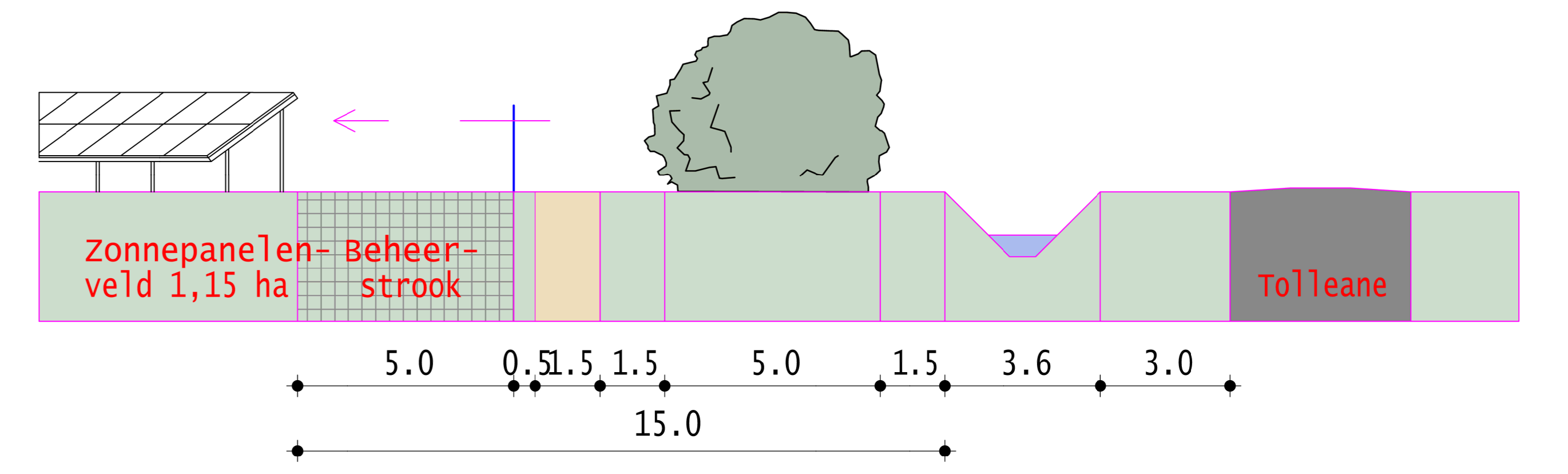

PROFIEL 2. ZUIDOOSTRAND - TOLLEANE

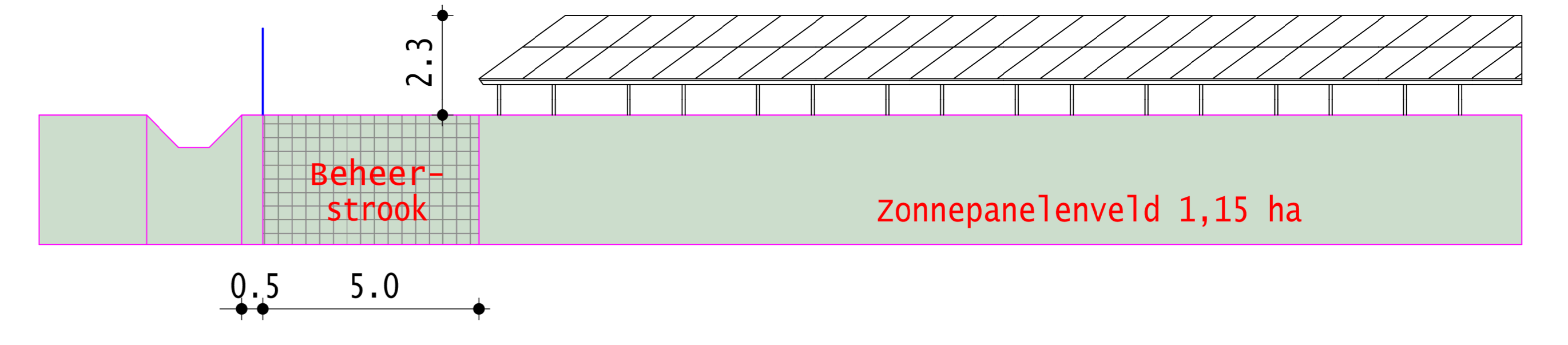

PROFIEL 3. ZUIDOOSTRAND

Doorsnede Hek:
schaal 1:100

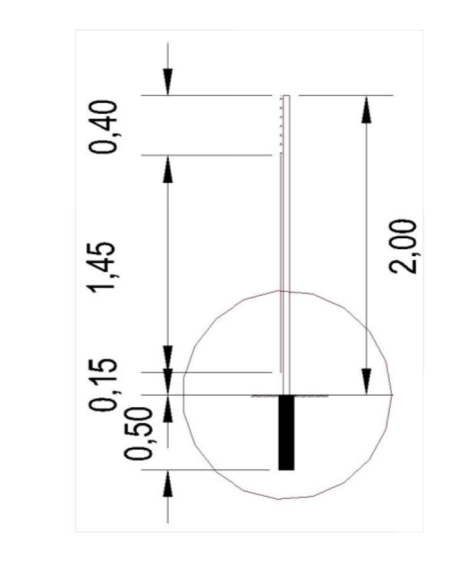

Doorsnede Paneeltafel:
schaal 1:100



Foto Hek:



Foto Paneeltafel:

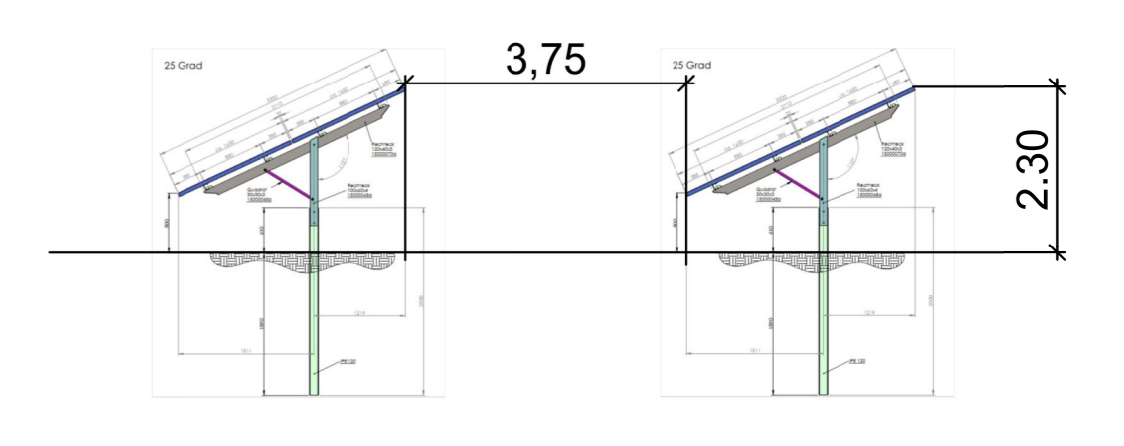

Locatie RWZI-Tolleane:
niet op schaal:

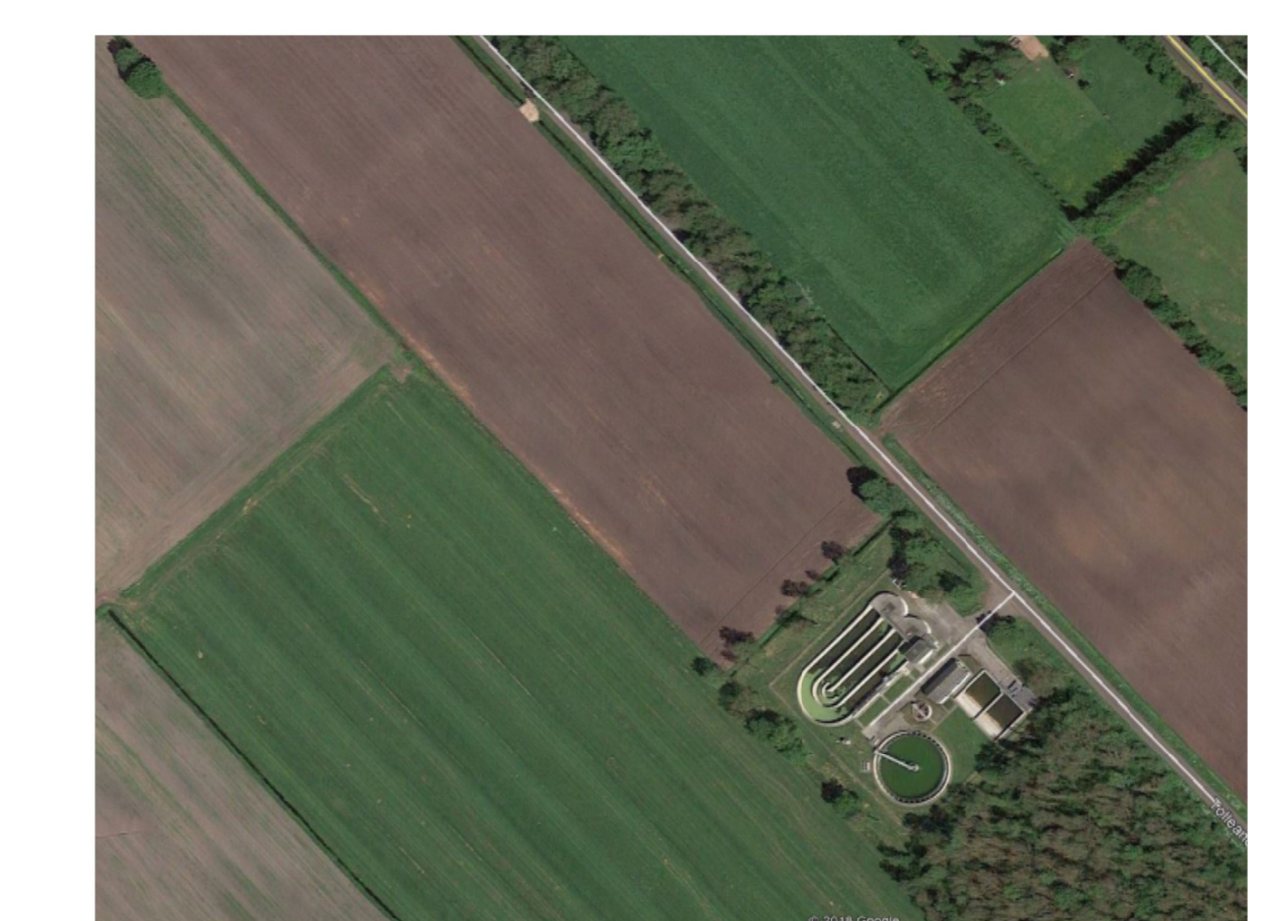

opdrachtgever Wijnjewoude Energie Neutraal	project Zonneakker RWZI Tolleane Tolleane Wijnjewoude
---	--

soltec services
Soltec services b.v.
Monierweg 5c
7741KV Coevorden
Tel +31 (0)85 2736758
Tel +31 (0)6 18 72 27 27
E mail reijer@soltecservices.nl

001	schaal gewijz.	16.09.2019	Kip
Index	wijziging	datum	naam

blad: 1/1	project: WEN
grootte: DIN A0	project: RWZI Tolleane
soonspr.: RZW1100	tekening: Bouwvergunningstekening
stand: 9.09.2019	tekening: Zonneakker RWZI Tolleane
editor: 09.09.2019 User	tekening: WEN Wijnjewoude
gspr: 09.09.2019	vakgebied: Zonnepaneleninstallatie
	schaal: 1:500