

EAZ Wind  
 Cort van de Lindenstraat 19  
 2288 EV Rijswijk  
 T +31(0)70 7780680  
 info@eazwind.com

EAZ-Twaalf

Overzicht

Form. : A4 297x210

Schaal : 1:140

Datum : 27-4-2015

Get. : Ziel

 Third Angle

Proj.

Tek. nr. :-

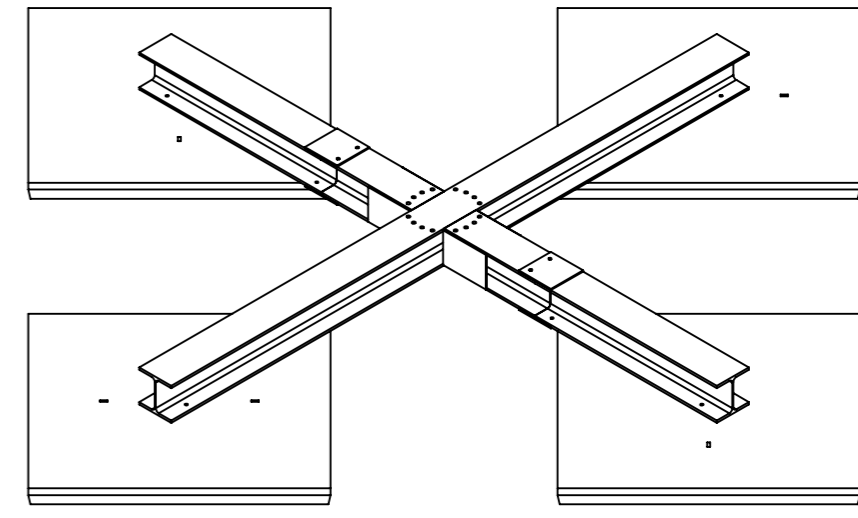
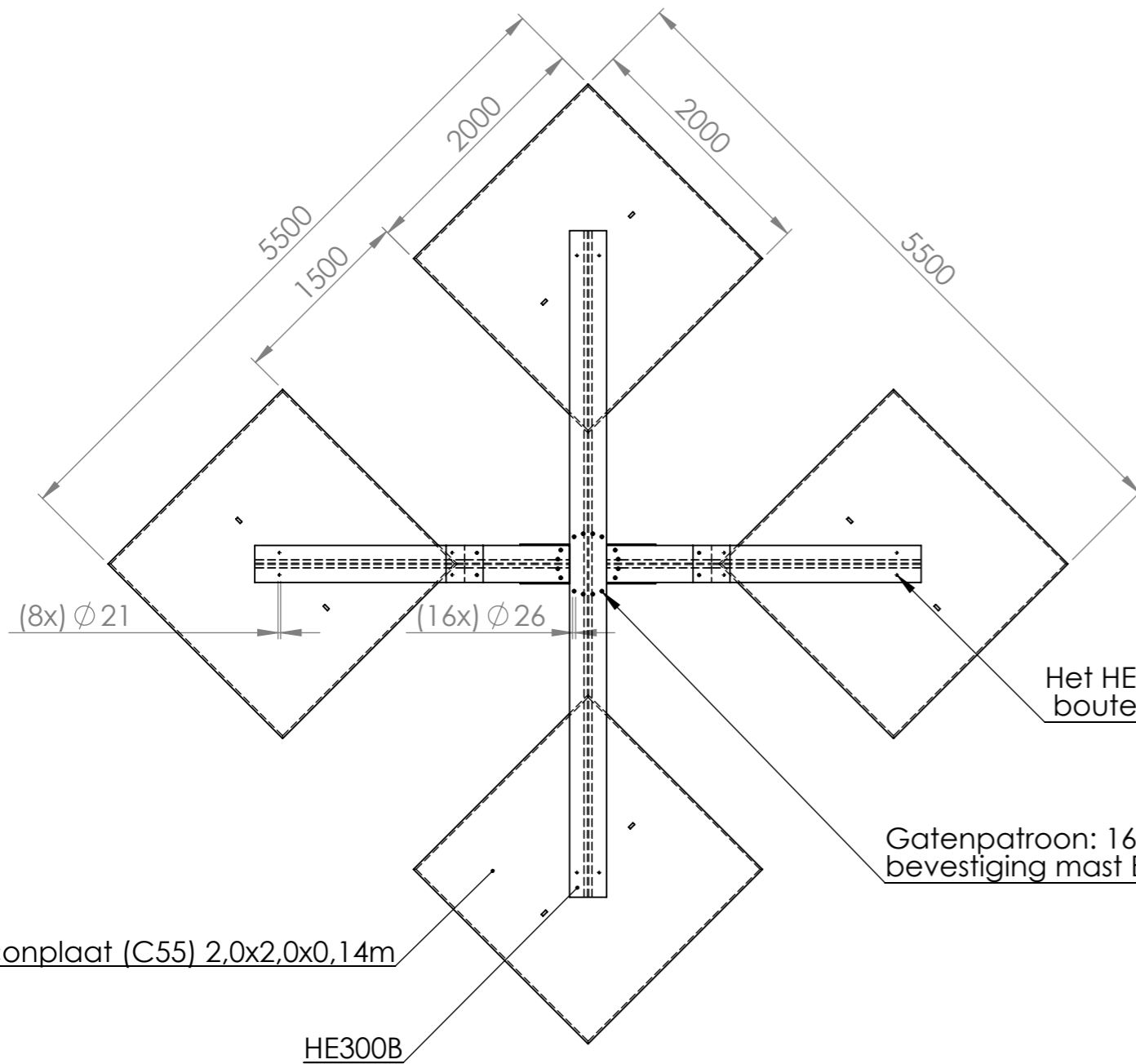

Het HE300B profiel is verbonden met 2 x M20 bouten aan een stelconplaat (C55)

Gatenpatroon: 16 x M24 bouten voor bevestiging mast EAZ-12

Stelconplaat (C55) 2,0x2,0x0,14m

HE300B

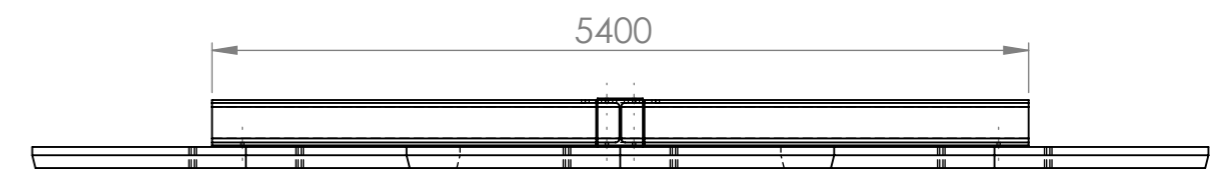
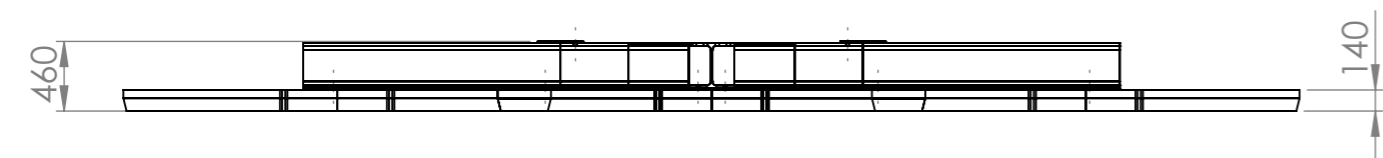

EAZ Wind  
Cort van der  
Lindestraat 19  
2288EV Rijswijk  
T +31(0)70-7780680  
info@eazwind.nl

Als niet anders aangegeven:  
Maten zijn in mm  
Tolerantie: +/- 0,1  
Materiaal: ---  
Opmerkingen:

<b>Naam samenstelling: Fundering EAZ - 12</b>	
Formaat : A3	Third Angle
Schaal: 1 : 50	
Datum: 14 - 01 - 2016	Proj. : EAZ - 12
Get. Willem Huijssoon	Tek. nr. : 12-001

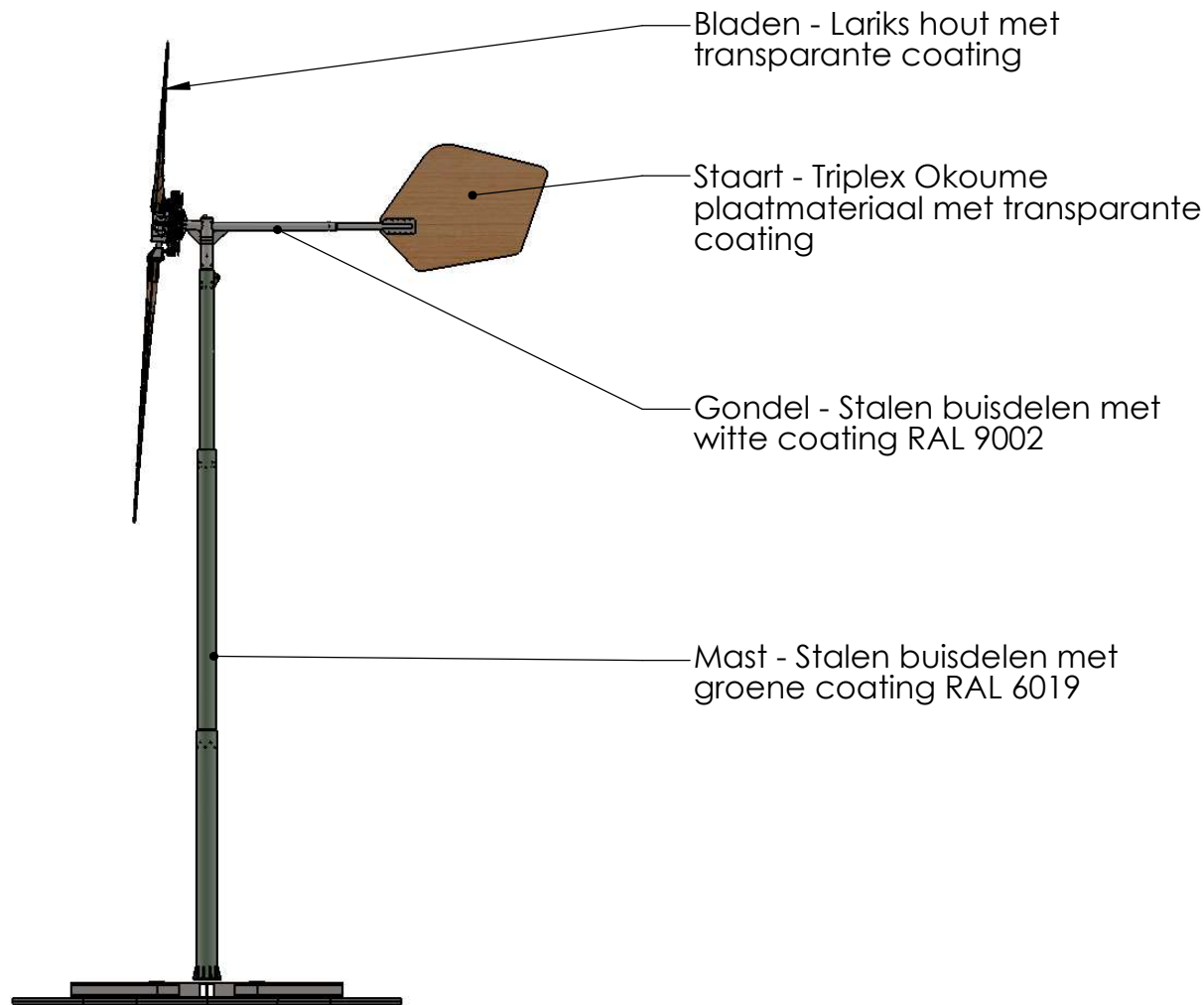
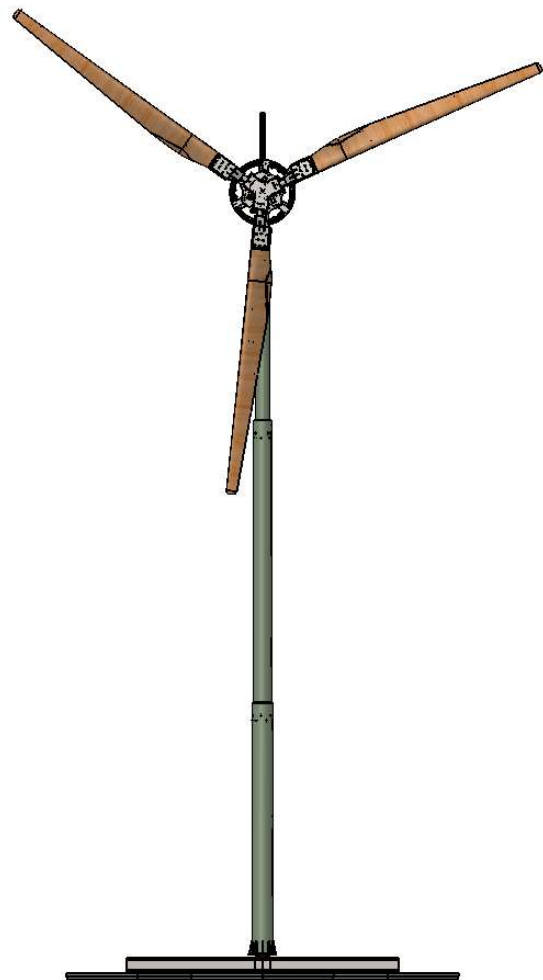

EAZ Wind  
Cort van de Lindestraat 19  
2288 EV Rijswijk  
T +31(0)70 7780680  
info@eazwind.com

### EAZ-Twaalf

Materiaal en kleurgebruik

Form. : A4 297x210

Schaal : 1:150

Datum : 22-08-2017

Get. : Ritsema

⊕ Third Angle

Proj.

Tek. nr. :-