

Mts. Poelman

Projectnummer: AL16-0752-01

Lichtplan voldoet aan de eisen
van het lichtconvenant.

Bedrijfsnaam: Agrifirm Exlan
Contactpersoon: Dhr. Johan Keizer
Adres: Noordeinde 31
Postcode / Plaats: 7940 KA Meppel
Telefoonnummer: 088 48 82 906

Datum: 06.06.2016
Operator: Mark Vis

Agrilight b.v.
 Vlotlaan 643
 2681 TZ Monster

Operator Mark Vis
 Telefoon +31 - 174 287 287
 Fax
 e-Mail mv@agrilight.com

Mts. Poelman / Samenvatting

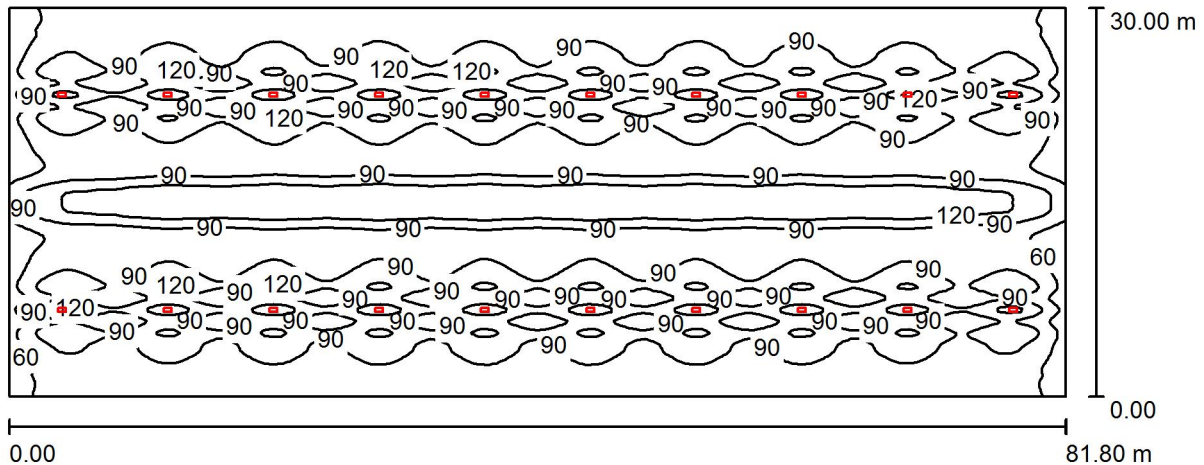

Hoogte van de ruimte: 9.600 m, Montagehoogte: 5.900 m, Behoudfactor: 0.85

Waarden in Lux, Schaal 1:585

Vlak	ρ [%]	E_{gem} [lx]	E_s [lx]	E_{max} [lx]	E_s / E_{gem}
Werkvlak	/	92	41	150	0.447
Vloer	10	88	37	121	0.421
Plafonds (2)	20	11	7.29	20	/
Muren (4)	20	52	6.28	119	/

Werkvlak:

Hoogte: 0.700 m
 Raster: 128 x 128 Punten
 Randzone: 0.000 m

Armaturen stuklijst

Nr.	Stuk	Type (Correctiefactor)	Φ (Armatuur) [lm]	Φ (Lampen) [lm]	P [W]
1	20	AGRILED® pro 16 355934 pro 16 355934 pro 16 (1.000)	15342	18000	125.0
Totaal:			306834	Totaal: 360000	2500.0

Specifiek vermogen: $1.02 \text{ W/m}^2 = 1.11 \text{ W/m}^2/100 \text{ lx}$ (Oppervlakte: 2454.00 m^2)

Agrilight b.v.
Vlotlaan 643
2681 TZ Monster

Operator Mark Vis
Telefoon +31 - 174 287 287
Fax
e-Mail mv@agrilight.com

Mts. Poelman / Stuklijst armaturen

20 Stuk AGRILED® pro 16 355934 pro 16 355934 pro 16
 Artikelnr.: 355934 pro 16
 Lichtstroom (Armatuur): 15342 lm
 Lichtstroom (Lampen): 18000 lm
 Armatuurvermogen: 125.0 W
 Armatuurcategorie volgens CIE: 100
 CIE Flux code: 30 67 97 100 85
 Uitrusting: 1 x LED (Correctiefactor 1.000).

In de
armaturen­katalogus
vindt u een afbeelding
van het armatuur.

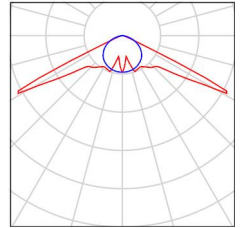

Agrilight b.v.
Vlotlaan 643
2681 TZ Monster

Operator Mark Vis
Telefoon +31 - 174 287 287
Fax
e-Mail mv@agrilight.com

Mts. Poelman / Armaturen (positieschema)

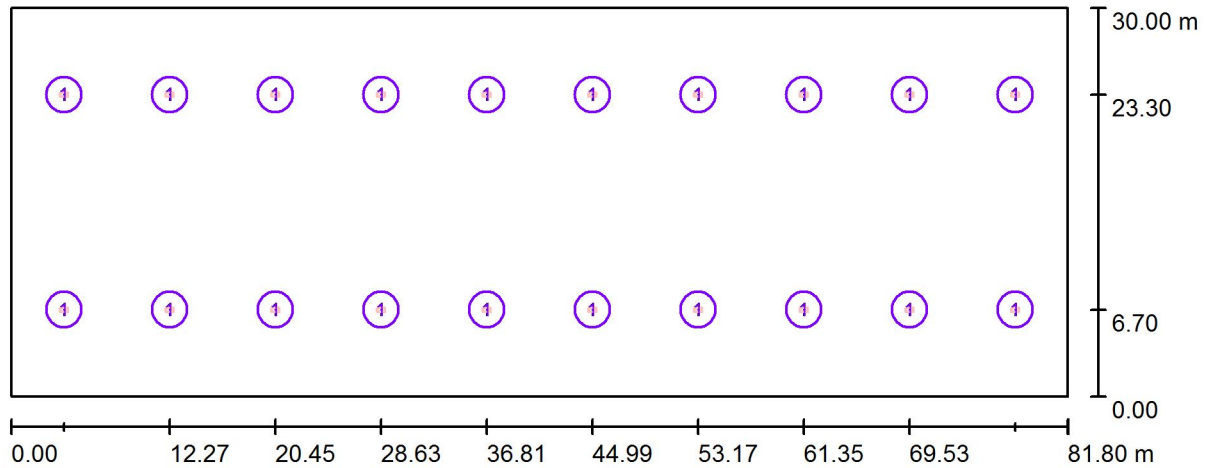

Schaal 1 : 585

Armaturen stuklijst

Nr.	Stuk	Type
1	20	AGRILED® pro 16 355934 pro 16 355934 pro 16

Agrilight b.v.
 Vlotlaan 643
 2681 TZ Monster

Operator Mark Vis
 Telefoon +31 - 174 287 287
 Fax
 e-Mail mv@agrilight.com

Mts. Poelman / Berekeningsraster (coördinatenlijst)

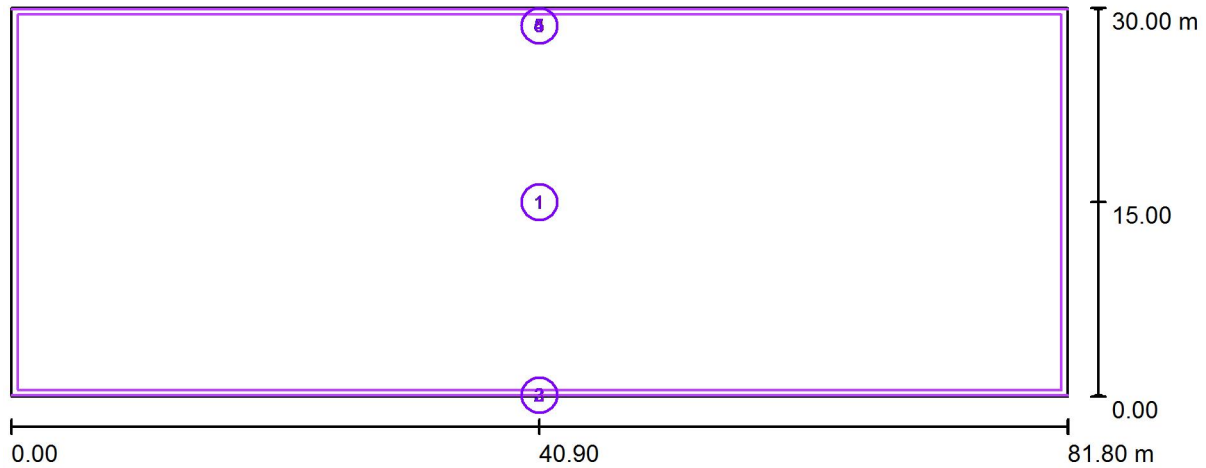

Schaal 1 : 585

Lijst van berekeningsraster

Nr.	Type	Positie [m]			Grootte [m]		Rotatie [°]		
		X	Y	Z	L	B	X	Y	Z
1	4 rijen ligboxen	40.900	15.000	0.700	80.800	29.000	0.0	0.0	0.0
2	scherm open (eis gem. 60 lux)	40.900	0.100	2.250	81.800	2.500	-90.0	0.0	0.0
3	scherm dicht (eis gem. 60 lux)	40.900	0.100	2.250	81.800	2.500	-90.0	0.0	0.0
4	scherm open (eis gem. 60 lux)	40.900	29.900	2.250	81.800	2.500	-90.0	0.0	180.0

Agrilight b.v.
Vlotlaan 643
2681 TZ Monster

Operator Mark Vis
Telefoon +31 - 174 287 287
Fax
e-Mail mv@agrilight.com

Mts. Poelman / Berekeningsraster (coördinatenlijst)

Lijst van berekeningsraster

Nr.	Type	Positie [m]			Grootte [m]		Rotatie [°]		
		X	Y	Z	L	B	X	Y	Z
5	scherm dicht (eis gem. 60 lux)	40.900	29.900	2.250	81.800	2.500	-90.0	0.0	-180.0

Agrilight b.v.
Vlotlaan 643
2681 TZ Monster

Operator Mark Vis
Telefoon +31 - 174 287 287
Fax
e-Mail mv@agrilight.com

Mts. Poelman / 3D Rendering

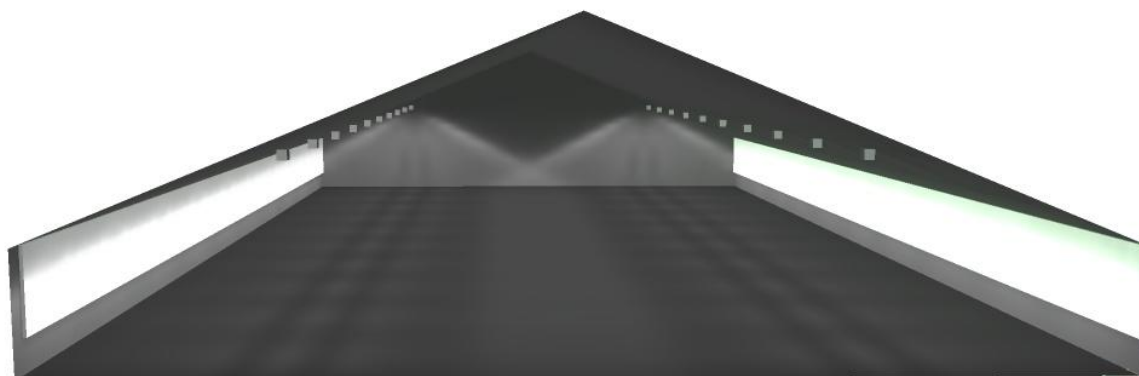

Agrilight b.v.
Vlotlaan 643
2681 TZ Monster

Operator Mark Vis
Telefoon +31 - 174 287 287
Fax
e-Mail mv@agrilight.com

Mts. Poelman / Rendering onjuiste kleuren

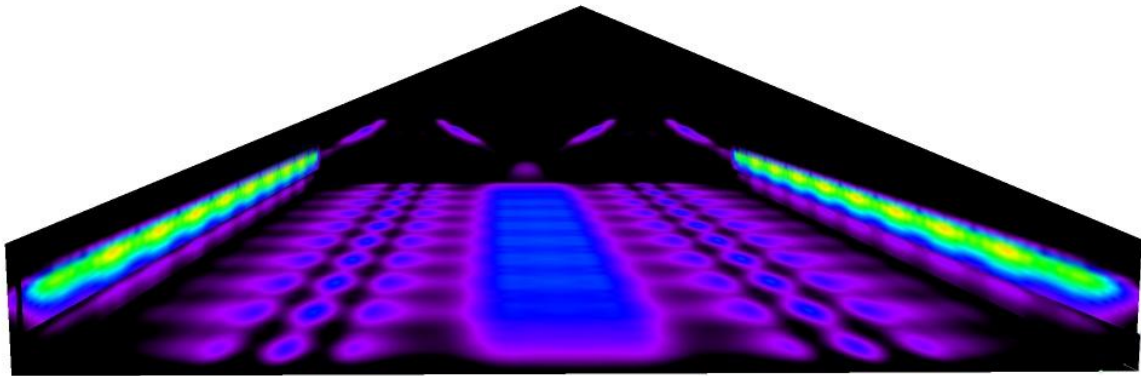

70 92.50 115 137.50 160 182.50 205 227.50 250

lx

Agrilight b.v.
 Vlotlaan 643
 2681 TZ Monster

Operator Mark Vis
 Telefoon +31 - 174 287 287
 Fax
 e-Mail mv@agrilight.com

Mts. Poelman / 4 rijen ligboxen / Isolijnen (E, loodrecht)

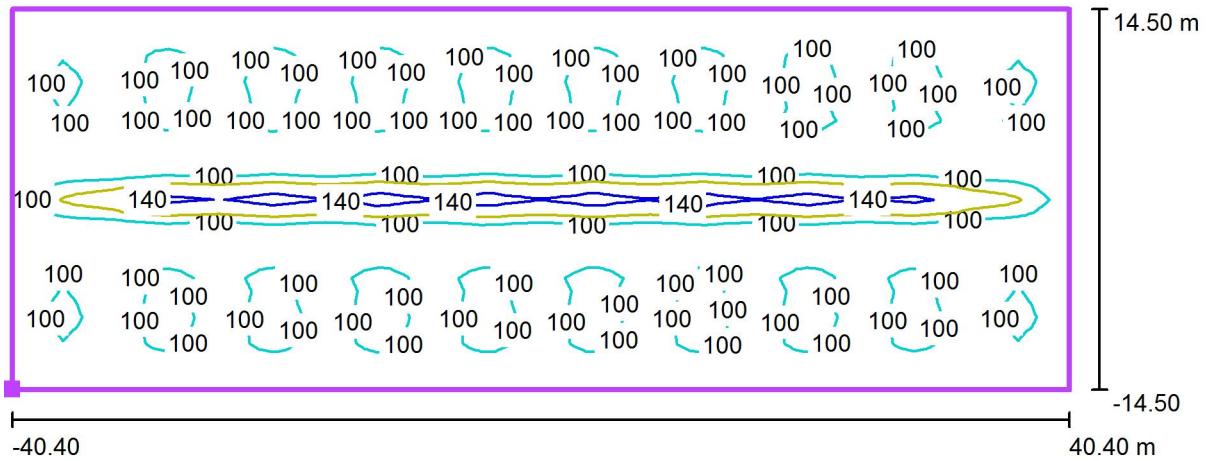

Waarden in Lux, Schaal 1 : 578

Positie van het vlak in de ruimte:
 Gemarkerd punt: (0.500 m,
 0.500 m, 0.700 m)



Raster: 81 x 30 Punten

E_{gem} [lx]	E_s [lx]	E_{max} [lx]	E_s / E_{gem}	E_s / E_{max}
92	47	149	0.51	0.32

Agrilight b.v.
 Vlotlaan 643
 2681 TZ Monster

Operator Mark Vis
 Telefoon +31 - 174 287 287
 Fax
 e-Mail mv@agrilight.com

Mts. Poelman / scherm open (eis gem. 60 lux) / Isolijnen (E, verticaal)

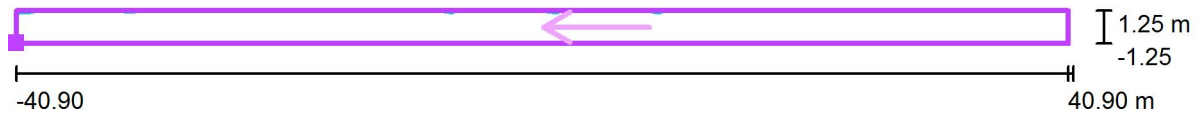

Waarden in Lux, Schaal 1 : 585

Positie van het vlak in de ruimte:
 Gemarkerd punt: (0.000 m,
 0.100 m, 3.500 m)

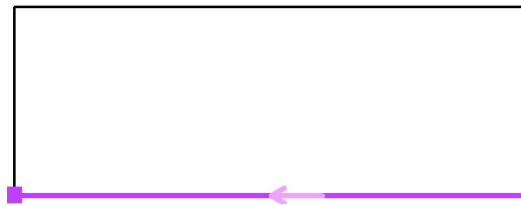

Raster: 82 x 3 Punten

E_{gem} [lx]	E_s [lx]	E_{max} [lx]	E_s / E_{gem}	E_s / E_{max}
16	0.00	57	0.00	0.00

Agrilight b.v.
 Vlotlaan 643
 2681 TZ Monster

Operator Mark Vis
 Telefoon +31 - 174 287 287
 Fax
 e-Mail mv@agrilight.com

Mts. Poelman / scherm dicht (eis gem. 60 lux) / Isolijnen (E, verticaal)

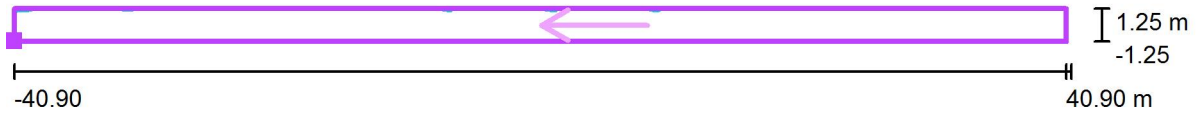

Waarden in Lux, Schaal 1 : 585

Positie van het vlak in de ruimte:
 Gemarkeerd punt: (0.000 m,
 0.100 m, 3.500 m)

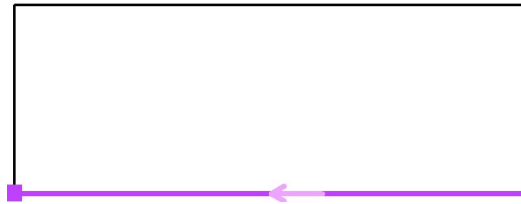

Raster: 82 x 3 Punten

E_{gem} [lx]	E_s [lx]	E_{max} [lx]	E_s / E_{gem}	E_s / E_{max}
16	0.00	57	0.00	0.00

Agrilight b.v.
 Vlotlaan 643
 2681 TZ Monster

Operator Mark Vis
 Telefoon +31 - 174 287 287
 Fax
 e-Mail mv@agrilight.com

Mts. Poelman / scherm open (eis gem. 60 lux) / Isolijnen (E, verticaal)

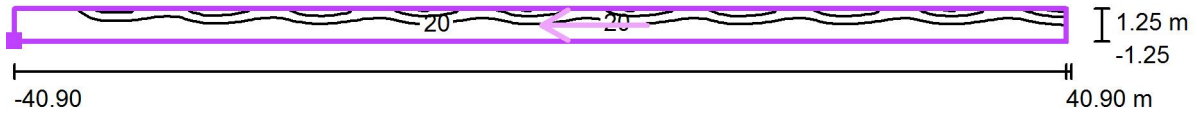

Waarden in Lux, Schaal 1 : 585

Positie van het vlak in de ruimte:
 Gemarkerd punt: (81.800 m,
 29.900 m, 3.500 m)

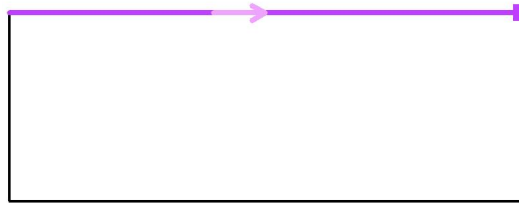

Raster: 82 x 3 Punten

E_{gem} [lx]	E_s [lx]	E_{max} [lx]	E_s / E_{gem}	E_s / E_{max}
16	0.00	58	0.00	0.00

Agrilight b.v.
 Vlotlaan 643
 2681 TZ Monster

Operator Mark Vis
 Telefoon +31 - 174 287 287
 Fax
 e-Mail mv@agrilight.com

Mts. Poelman / scherm dicht (eis gem. 60 lux) / Isolijnen (E, verticaal)

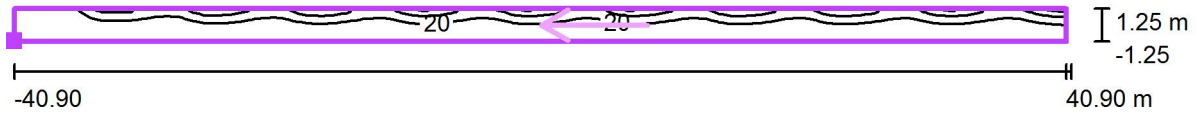

Waarden in Lux, Schaal 1 : 585

Positie van het vlak in de ruimte:
 Gemarkeerd punt: (81.800 m,
 29.900 m, 3.500 m)

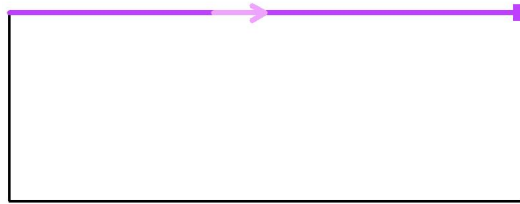

Raster: 82 x 3 Punten

E_{gem} [lx]	E_s [lx]	E_{max} [lx]	E_s / E_{gem}	E_s / E_{max}
16	0.00	58	0.00	0.00